

Standard fastening material

Sleeper screw Ss 8/160

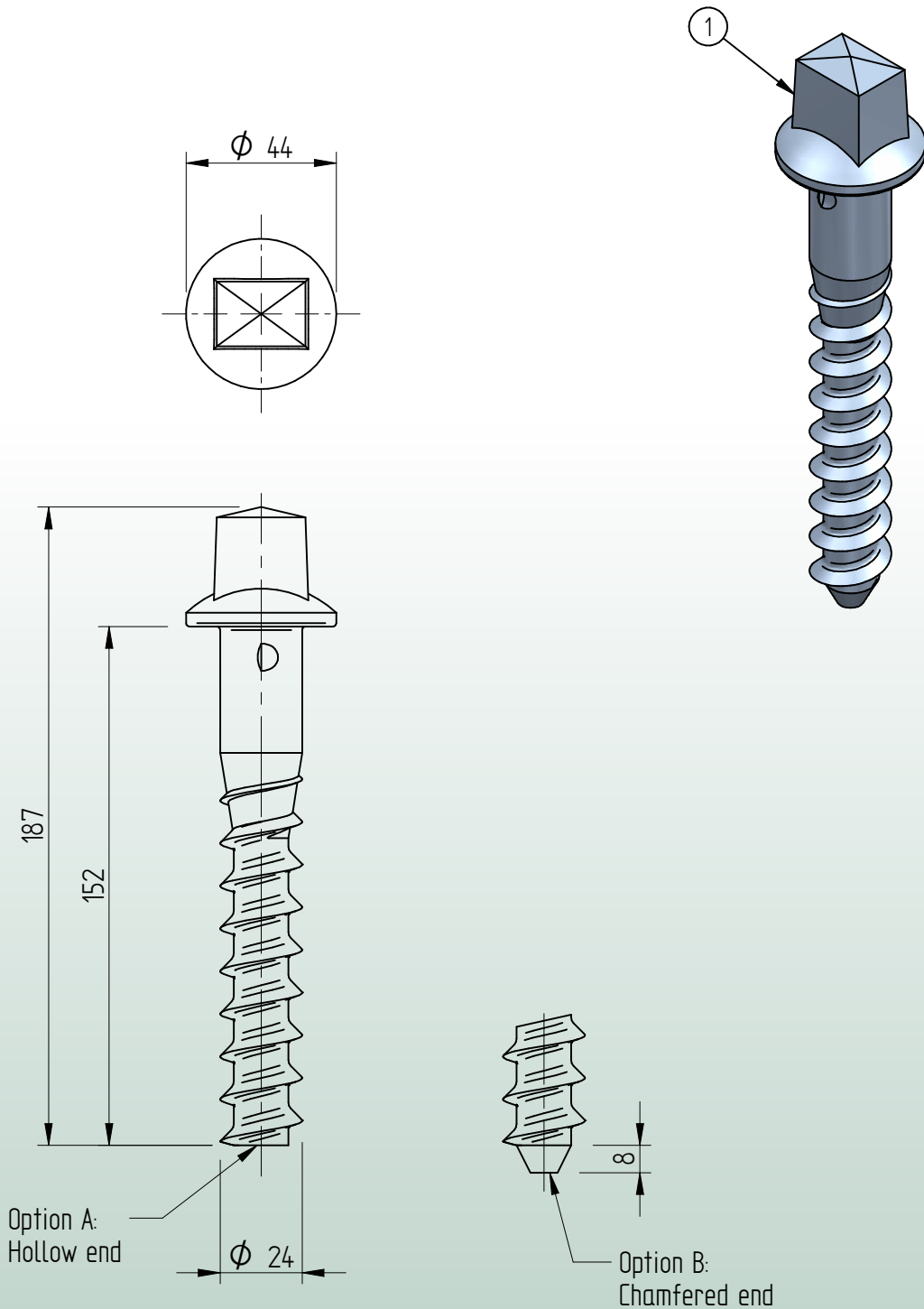

* Standard preservation is hot dip galvanized and standard material grade is 4.6.
Other preservation and grade options in agreement.

1	Sleeper screw / Ss8	*	SS8 / $\phi 24 \times 160$		m = 0,565 [kg]
Item	Description	Material	Type / Dimensions	Norm	Comments

BEMORAIL 

Debbemeerweg 59
1749 DK Warmenhuizen
The Netherlands

Tel.: +31 (0)226 425300
E-mail: info@bemorail.com
www.bemorail.com